

Description

- ◆ The common mode filter is mainly used to reduce radiation and high frequency common mode noise.
- ◆ Reduce asymmetric interference on data lines and other interfaces.
- ◆ Impedance characteristics match the impedance of most differential interface Settings, controlling unnecessary reflection formation
- ◆ Low leakage, no effect on differential mode current



Features

- ◆ Size:2.0mm*1.2mm*1.2mm
- ◆ Halogen free ,Lead free ,Reach and RoHs

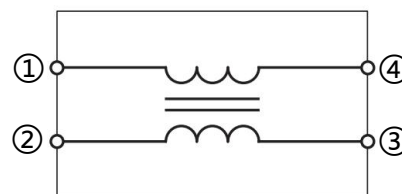

Circuit Diagram

Application

- ◆ Cellular phones
- ◆ Portable devices
- ◆ Digital cameras
- ◆ Player
- ◆ Smart home
- ◆ Robot

PIN NUMBER	DESCRIPTION
① ~ ④	DATE LINE
② ~ ③	DATE LINE

Order information

Model	Marking	Package	shipping
CMF2012WA900MQT		2012	2000/Tape&Reel

Part Numbering

CMF	2012	W	A	900	M	Q	T
A	B	C	D	E	F	G	H

A:ASIM common mode filter

B:Dimension

C:Wire wound

D:Shielding type for 1.0GHz/USB2.0

E:Impedance 900=90Ω

F:Tolerance M±25%

G:Internal series

H:Tape

Specification

Part number	Common mode impedance(Ω) @100MHz	Rated Current (mA)	DC Resistance (Ω) max
CMF2012WA900MQT	90±25%	400	0.3
	Rated volt (Vdc)	Withstand volt (Vdc)	IR (Ω) min
	50	125	10M
	Operation junction temperature	Lead temperature	Storage temperature*
	-40°C~+85°C	260°C	-40°C~85°C

*The storage temperature is subject to the fixed substrate

Performance Curves

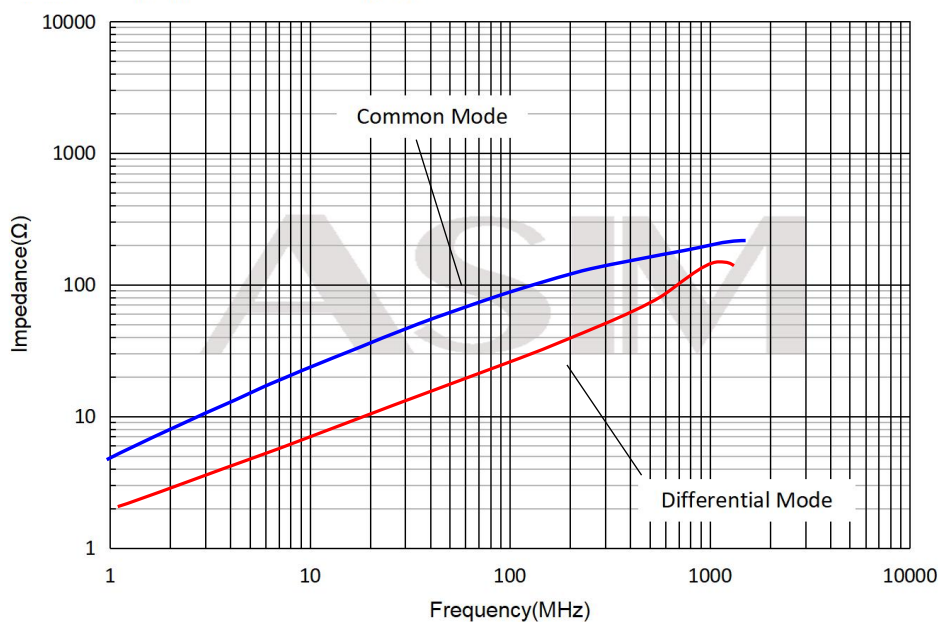

Transmission Characteristics

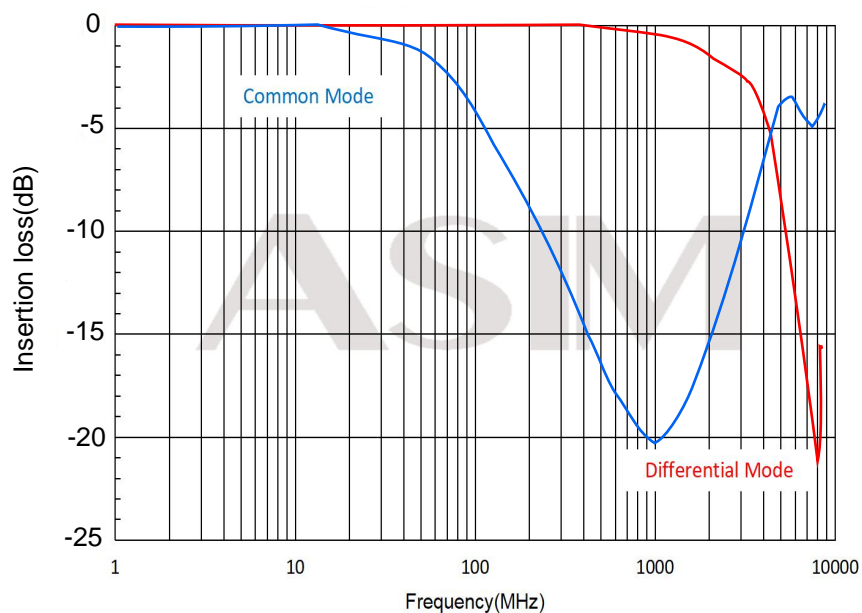

Dimension

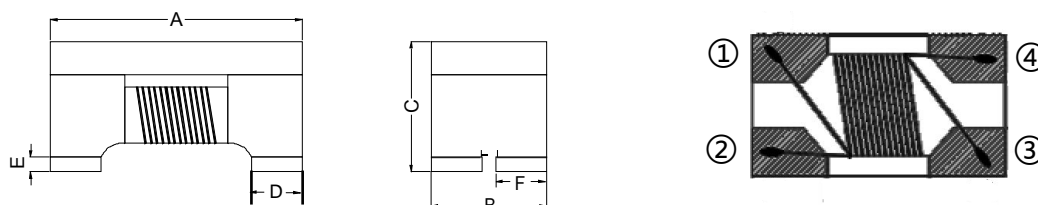

A(mm)	B(mm)	C(mm)	D(mm)	F(mm)	E(mm)
2.0±0.2	1.2±0.2	1.2±0.2	0.55±0.1	0.46±0.1	0.15±0.1

Recommended Land Pattern (mm)

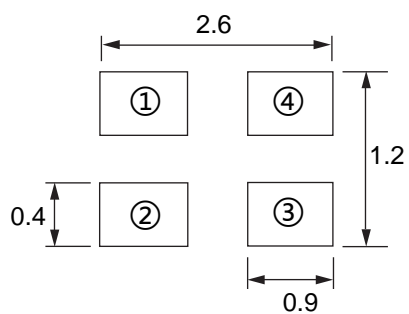

Recommended Reflow Profile

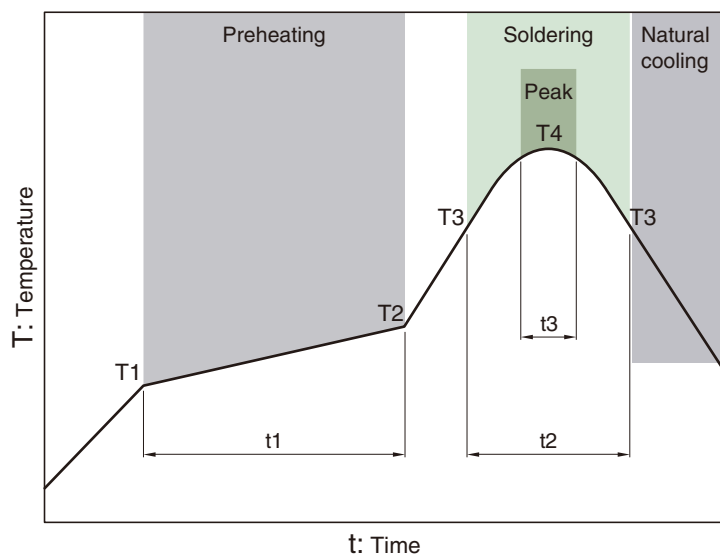

Preheating			Soldering		Peak	
Temp.	Temp.	Time	Temp.	Time	Temp.	Time
T1	T2	t1	T3	t2	T4	t3
150°C	180°C	60 to 120s	230°C	25 to 35s	250°C	5s

Reel Dimension&Tape Dimension

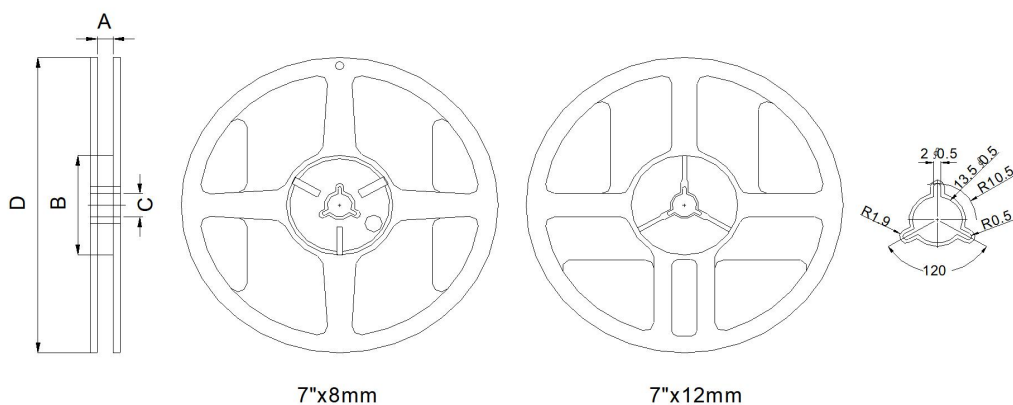

Type	A(mm)	B(mm)	C(mm)	D(mm)
7"x8mm	9.0±0.5	60±2	13.5±0.5	178±2
7"x12mm	13.5±0.5	60±2	13.5±0.5	178±2

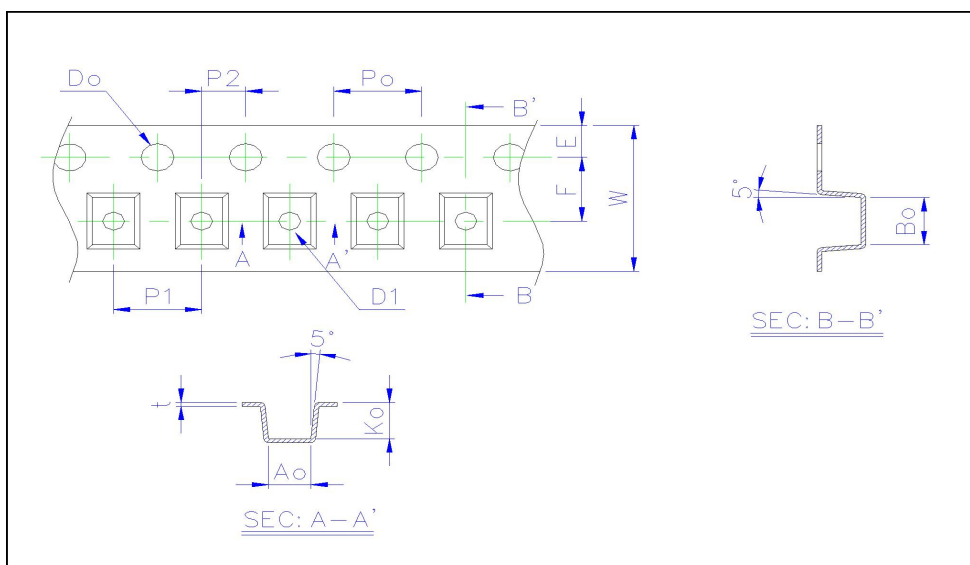

Size	Ao(mm)	Bo(mm)	Ko(mm)	W(mm)	E(mm)	F(mm)	Po(mm)	P1(mm)	Do(mm)
1608	1.00±0.10	1.65±0.10	1.18±0.10	8.00±0.20	1.75±0.10	3.50±0.05	4.0±0.05	4.0±0.10	none
2012	1.50±0.10	2.35±0.10	1.45±0.10	8.00±0.20	1.75±0.10	3.50±0.05	4.0±0.05	4.0±0.10	1.0±0.1
3216	1.88±0.10	3.50±0.10	2.10±0.10	8.00±0.20	1.75±0.10	3.50±0.05	4.0±0.05	4.0±0.10	1.0±0.1